

α Therm



PROVIDING A TOTAL SOLUTION FOR
HIGH STANDARD SAFETY CIRCUIT PROTECTION

Alpha Therm GmbH: Ihr Offizieller Vertriebskanal für SETsafe/SETfuse

Die Alpha Therm GmbH mit Sitz in Plankstadt, Deutschland, ist stolz darauf, der offizielle Vertriebskanal für SETsafe/SETfuse in Deutschland, Europa und weltweit zu sein. Unsere langjährige Partnerschaft mit SETsafe/SETfuse basiert auf einem erfolgreichen und vertrauensvollen Geschäftsmodell.

Wir repräsentieren SETsafe/SETfuse auf internationalen Messen wie der Electronica, InterSolar, ees und vielen weiteren. Von kleinen Standardsicherungen bis hin zu komplexen, kundenspezifischen Automotive-Projekten – wir haben alles erfolgreich umgesetzt. Mit unserer umfassenden Lagerhaltung in Deutschland gewährleisten wir schnelle und zuverlässige Lieferungen.

Kontaktieren Sie uns! Unser kompetentes Team berät Sie ausführlich und findet die optimale Lösung für Ihre Anforderungen. Vertrauen Sie auf Alpha Therm GmbH und SETsafe/SETfuse – Ihre Partner für innovative Sicherheitslösungen.

Kontakt:

- Tel.: [+49] 6202 / 575688 - 0
- E-Mail: sales@alpha-therm.de

Alpha Therm GmbH: Your Official Distribution Channel for SETsafe/SETfuse

Alpha Therm GmbH, based in Plankstadt, Germany, is proud to be the official distribution channel for SETsafe/SETfuse in Germany, Europe, and worldwide. Our long-standing partnership with SETsafe/SETfuse is built on a successful and trustworthy business model.

We represent SETsafe/SETfuse at international trade fairs such as Electronica, InterSolar, ees, and many more. From small standard fuses to complex, customized automotive projects, we have successfully handled it all. With our extensive warehousing in Germany, we ensure fast and reliable deliveries.

Contact us today! Our competent team will provide you with detailed advice and find the optimal solution for your requirements. Trust Alpha Therm GmbH and SETsafe/SETfuse – your partners for innovative safety solutions.

Alpha Therm GmbH
Gewerbering 7
68723 Plankstadt
Germany

Tel: +49 (0) 6202 / 575688 - 0 Fax: -10
E-Mail: sales@alpha-therm.de
Web: www.alpha-therm.com

Thermal-Link (OTCO)-Organic Type

RK Series I_r : 20A



Description

Organic Thermal-Link (OTCO) RK series is defined as a non-resettable protective device, functioning one time only. It mainly consists of metal case, spring, conductive nail, sliding contact and thermal pellet. When the Thermal-Link senses abnormal heat and temp. reaches the predetermined fusing temp., thermal pellet melts and the conductive nail separates from the isolated lead with the assistance of the trip spring, thereby the circuit is disconnected.

SETsafe | SETfuse Organic Thermal-Link (OTCO) RK series Rated Functioning Temp. from 72 °C to 310 °C, Rated Current: 20 A, Rated Voltage: 250VAC, safety certification Includes UL, cUL, and complies with RoHS and REACH.

Features

- High Accuracy of Functioning Temp.
- Non-Resettable
- Organic Thermal Pellet
- Metal Case
- Low Resistance
- RoHS & REACH Compliant

Applications

- Kitchen and Toilet Appliance
- Environment Appliances
- Cleaning Appliances
- Electric Tool
- Automotive Electronics
- Office Equipment
- Motor

Customization

- Other Temp.
- The Length of Lead Wires
- Taping Packing Available
- Leads Forming Types

Cylindrical Structure Diagrams

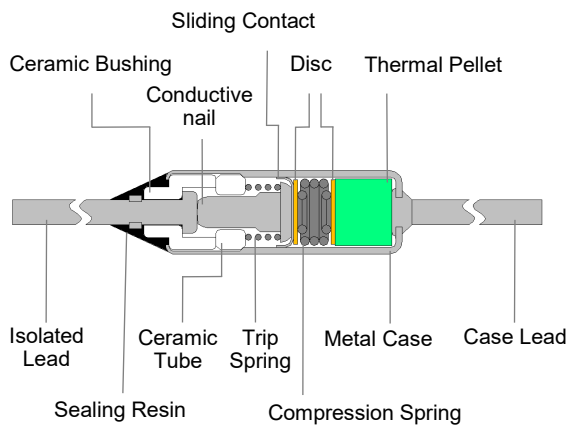

Square Structure Diagrams

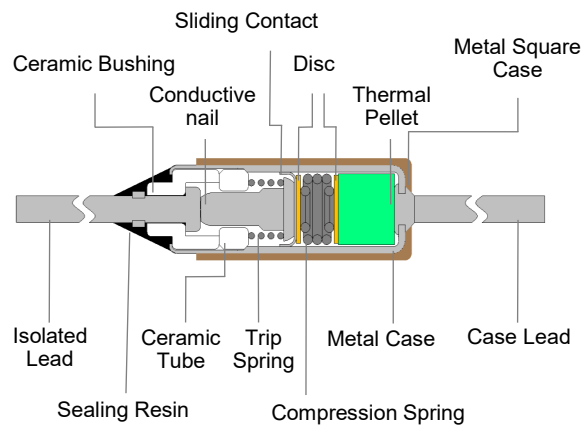

Cylindrical Structure Marking

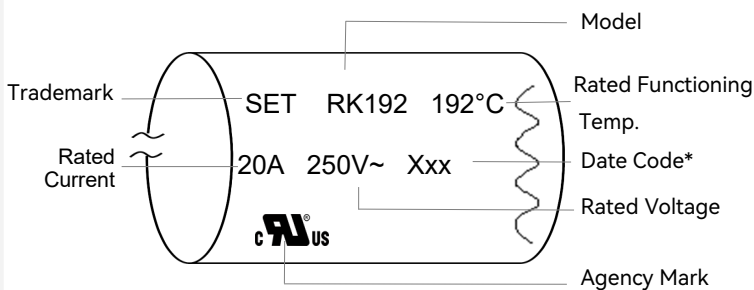

Square Structure Marking

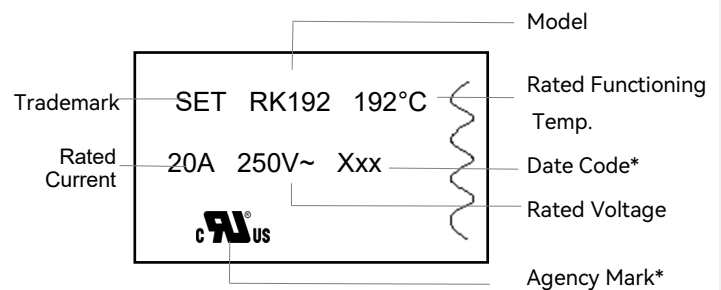

Remark:

1: The Date Code means Year and quarter: A stands for 2000, B stands for 2001 and 01 stands for the first quarter, 02 stands for the second quarter, and so on.

Cylindrical Structure Dimensions (mm)

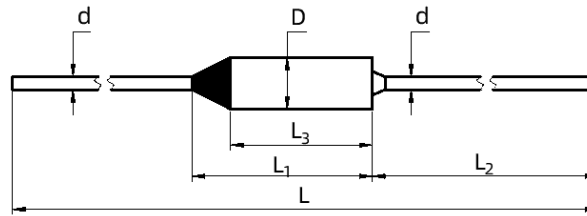

Lead Length	L	L ₁	L ₂	L ₃	D	d
Standard	65 ± 3	(14)	35 ± 2	(11.5)	Φ 4 ± 0.2	Φ 1.2 ± 0.1
Long	81 ± 3	(14)	35 ± 2	(11.5)	Φ 4 ± 0.2	Φ 1.2 ± 0.1
Option	Customization	(14)	Customization	(11.5)	Φ 4 ± 0.2	Φ 1.2 ± 0.1

Remark: The dimensions in parentheses are for reference only.

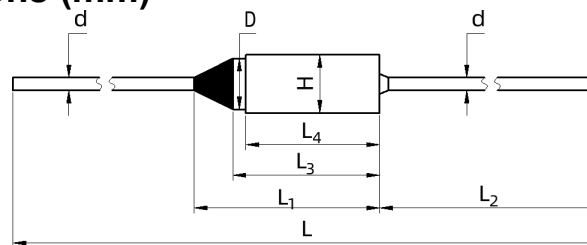

Square Structure Dimensions (mm)









Lead Length	L	L ₁	L ₂	L ₃	L ₄	D	H	d
Standard	65 ± 3	(14)	35 ± 2	(11.5)	10.3 ± 0.5	Φ 4 ± 0.2	4.6 ± 0.3	Φ 1.2 ± 0.1
Long	81 ± 3	(14)	35 ± 2	(11.5)	10.3 ± 0.5	Φ 4 ± 0.2	4.6 ± 0.3	Φ 1.2 ± 0.1
Option	Customization	(14)	Customization	(11.5)	10.3 ± 0.5	Φ 4 ± 0.2	4.6 ± 0.3	Φ 1.2 ± 0.1

Remark: The dimensions in parentheses are for reference only.

Agency Information

Agency Symbol	Standards	The File No. and certification No. obtained by SETsafe SETfuse
	UL60691	E214712
	CAN-CSA-E60691	E214712

Specifications

	Model	Fusing Temp.	T_h^* (UL/cUL)	T_m	I_r	U_r							RoHS REACH
		(°C)	(°C)	(°C)	(A)	(VAC)	UL	cUL	TUV	PSE	KC	CCC	
310	RK310	304 ± 3	280	500	20	250	○	○	○	⊙	⊙	⊙	●
275	RK275	273 +2 / -3	260	500	20	250	●	●	⊙	⊙	⊙	⊙	●
263	RK263	261 ± 2	225	500	20	250	○	○	○	⊙	⊙	⊙	RoHS ● REACH *
257	RK257	254 ± 2	237	500	20	250	●	●	⊙	⊙	⊙	⊙	●
240	RK240	238 ± 2	220	500	20	250	●	●	⊙	⊙	⊙	⊙	●
229	RK229	227 ± 2	210	500	20	250	○	○	○	⊙	⊙	⊙	●
216	RK216	213 ± 2	203	500	20	250	●	●	⊙	⊙	⊙	⊙	●
205	RK205	203 ± 2	192	500	20	250	○	○	○	⊙	⊙	⊙	●
192	RK192	190 ± 2	179	500	20	250	●	●	⊙	⊙	⊙	⊙	●
184	RK184	181 ± 2	171	500	20	250	●	●	⊙	⊙	⊙	⊙	●
172	RK172	168 ± 2	159	500	20	250	○	○	○	⊙	⊙	⊙	●
167	RK167	164 ± 2	154	500	20	250	●	●	⊙	⊙	⊙	⊙	●
157	RK157	155 ± 2	144	500	20	250	○	○	⊙	⊙	⊙	⊙	●
152	RK152	149 ± 2	139	500	20	250	●	●	⊙	⊙	⊙	⊙	●
144	RK144	141 ± 2	131	500	20	250	●	●	⊙	⊙	⊙	⊙	●
134	RK134	131 ± 2	121	500	20	250	●	●	⊙	⊙	⊙	⊙	●
128	RK128	124 ± 2	115	500	20	250	●	●	⊙	⊙	⊙	⊙	●
121	RK121	118 ± 2	108	500	20	250	●	●	⊙	⊙	⊙	⊙	●
117	RK117	114 ± 2	104	500	20	250	○	○	○	⊙	⊙	⊙	●
110	RK110	108 ± 2	97	500	20	250	●	●	⊙	⊙	⊙	⊙	●
104	RK104	102 ± 2	91	500	20	250	○	○	○	⊙	⊙	⊙	●
98	RK98	95 ± 2	85	500	20	250	●	●	⊙	⊙	⊙	⊙	●
94	RK94	91 ± 2	81	500	20	250	○	○	○	⊙	⊙	⊙	●
84	RK84	82 ± 2	71	500	20	250	○	○	○	○	○	○	●
77	RK77	74 ± 2	64	500	20	250	●	●	○	○	○	○	●
72	RK72	69 ± 2	59	500	20	250	○	○	○	○	○	○	●

Note:

1. "●"Means certificated, "○"Means non-certificated, "⊙"Means Certification in progress, RoHS & REACH Compliant ." * " indicates that RK263 complies with REACH Directive 1907/2006/EC, SVHC Candidate List, Batch 29, Item 235 for most of the content (please consult SET for details).
2. For the T_h test, UL/cUL monitors the temperature of the product itself, while other standards monitor the ambient temperature inside the oven.
3. RK series with a T_f rating 175°C and above comply with UL conductive heat aging (CHAT) requirements.

Temp. Rise (Reference)

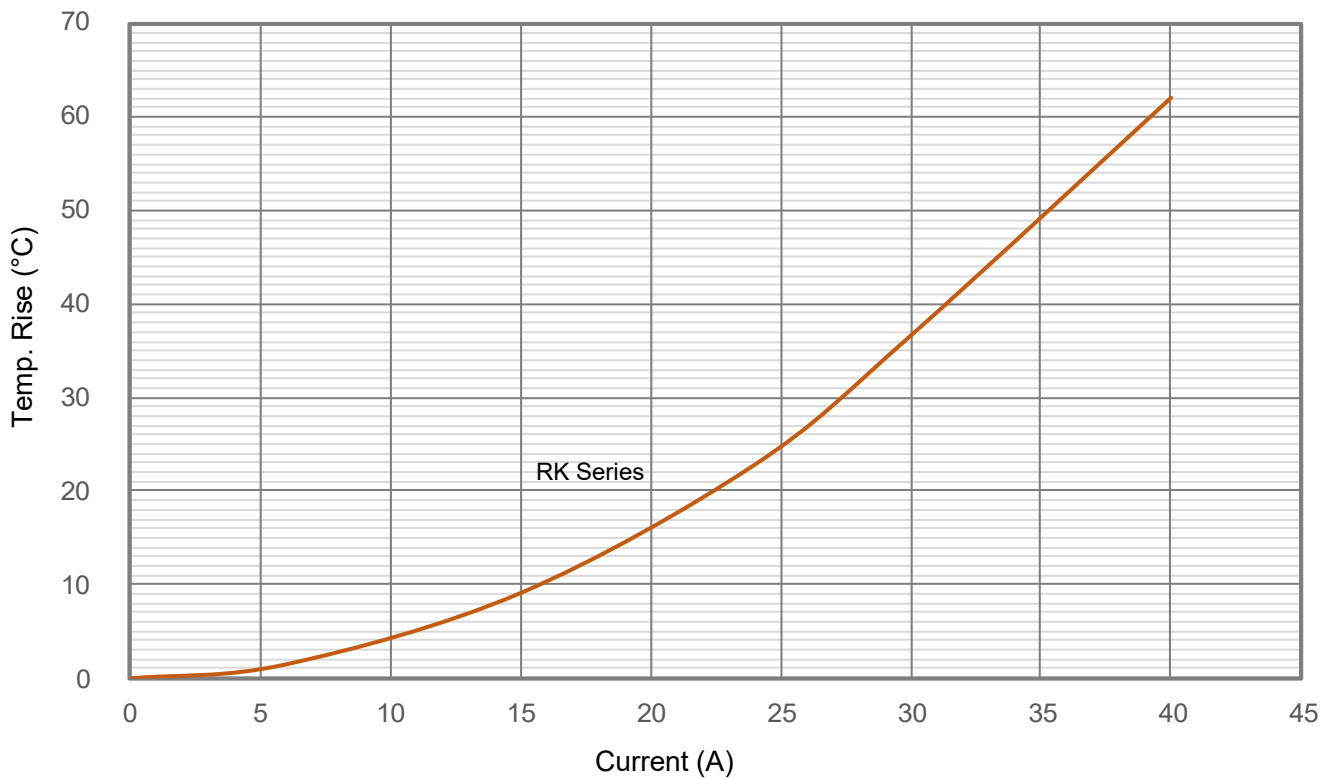

Note: The temperature rise test for square products is continuously updated. If you need data, please consult SET.

Packaging Information

1. Bulk

Item	PE Bag	PE Bag	Carton
Dimensions (mm)	135 x 85	220 x 190	346 x 316 x 156
Quantity (PCS)	100	1000	10000
Gross Weight (kg)			Cylindrical: 13.3 ± 10% Square: 20.3 ± 10%

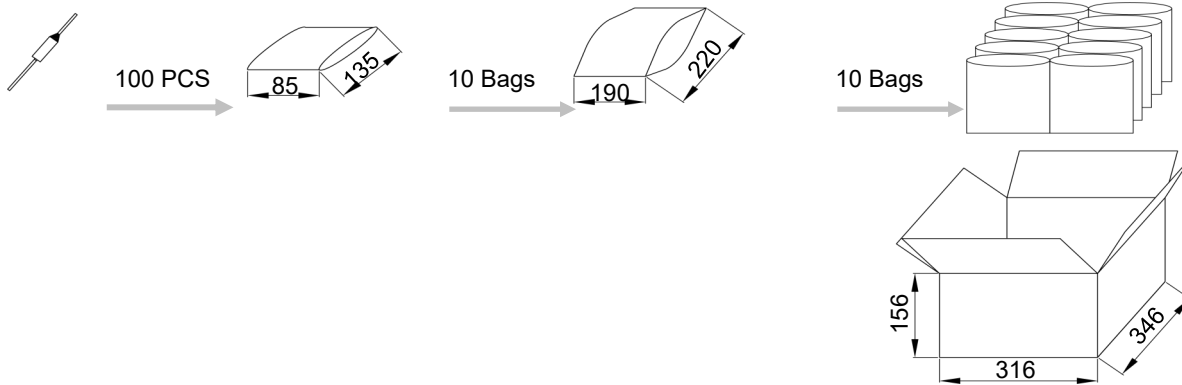

2. Taping

Item	Scroll	Box	Carton
Dimensions (mm)	Φ 250 x Φ 85 x 70	258 x 258 x 82	455 x 315 x 285
Quantity (PCS)	2000	2000	10000
Gross Weight (kg)			Cylindrical: 15.0 ± 10% Square: 22.0 ± 10%

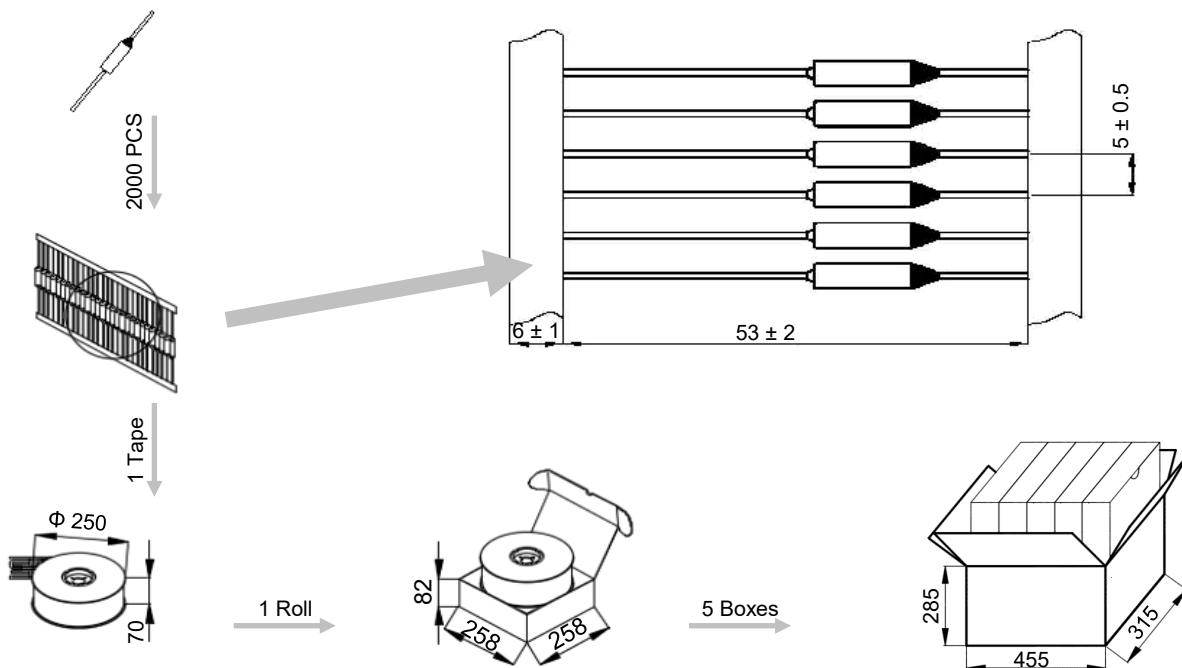

Part Numbering System

OTCO - RK 72 - L S A B - 001

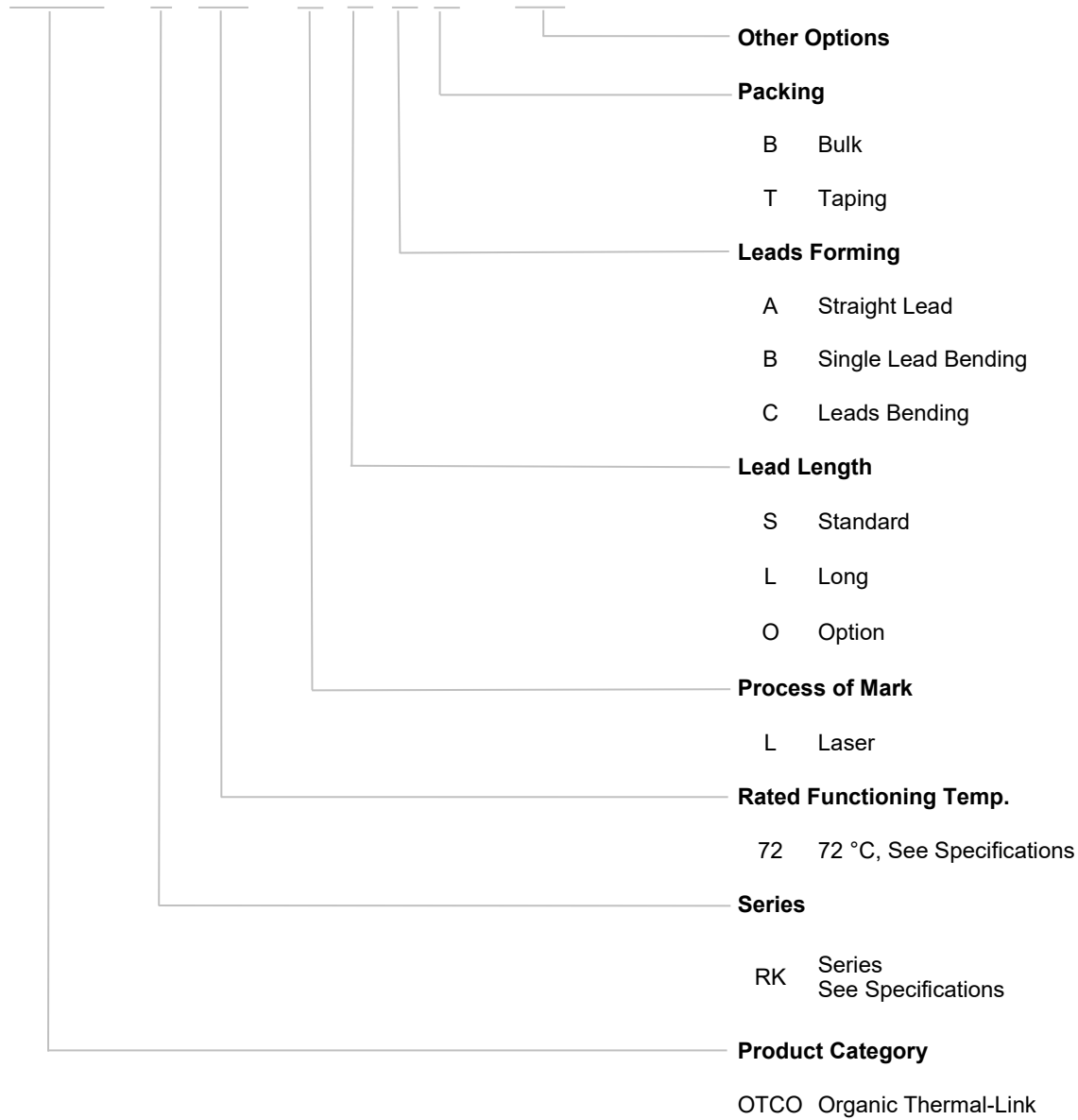

Glossary

Item	Description
TCO	<p>Thermal-Link A non-resettable device incorporating a THERMAL ELEMENT which will open a circuit once only when exposed for a sufficient length of time to a temperature in excess of that for which it has been designed.</p> <p style="text-align: right;">— (GB 9816.1)</p>
OTCO	<p>Organic Thermal-Link Organic type Thermal-Link, organic is the THERMAL ELEMENT.</p>
T_f	<p>Rated Functioning Temp. The temperature of the Alloy Thermal-Link which causes it to change the state of conductivity with a detection current up to 10 mA as the only load.</p> <p style="text-align: right;">— (GB 9816.1)</p> <p>Tolerance: T_f °C (GB 9816.1, EN 60691, K60691). Tolerance: $T_f \pm 7$ °C (J60691).</p>
Fusing Temp.	<p>Fusing Temp. The temperature of the Alloy Thermal-Link which causes it to change its state of conductivity is measured with silicone oil bath in which the temperature is increased at the rate of 0.5 °C to 1 °C / minute, with a detection current up to 10 mA as the only load.</p> <p style="text-align: right;">— (GB 9816.1)</p>
T_h	<p>Holding Temp. The Maximum temperature at which a Alloy Thermal-Link will not change its state of conductivity when conducting rated current for 168 hours.</p> <p style="text-align: right;">— (GB 9816.1)</p>
T_m	<p>Maximum Temp. Limit The temperature of the Alloy Thermal-Link stated by the manufacturer, up to which the mechanical and electrical properties of the Alloy Thermal-Link having changed its state of conductivity, will not be impaired for a given time.</p> <p style="text-align: right;">— (GB 9816.1)</p>
I_r	<p>Rated Current Current used to classify a Thermal-Link.</p> <p style="text-align: right;">— (IEC60691)</p>
U_r	<p>Rated Voltage Voltage used to classify a Thermal-Link.</p> <p style="text-align: right;">— (IEC60691)</p>



ATTENTION

Usage

1. Please use OTCO without exceeding the rated current and voltage.
2. Do not use the OTCO in environments out of the standard specifications, such as those containing sulfur dioxide gas, nitrogen oxide gas, ammonia gas or formic acid. It is also not suitable for using in high humidity environment or immersed in liquid.

Replace

OTCO is a non-repairable product. For safety aspect, it shall be replaced by an equivalent OTCO from the same manufacturer, and mounted in the same way.

Storage

1. OTCO must be kept in a place with no sunshine or corrosive gas, the temperature shall be within 10 °C ~ 30 °C and humidity within 30 % ~ 70 %. The validity storage period of OTCO is 12 months after purchase.
2. The case and isolated lead of OTCO are silver-plated. Therefore, to avoid vulcanization, the OTCO shall not be kept around materials such as cardboard or rubber etc. which generate sulfurous acid gas.

Lead Process

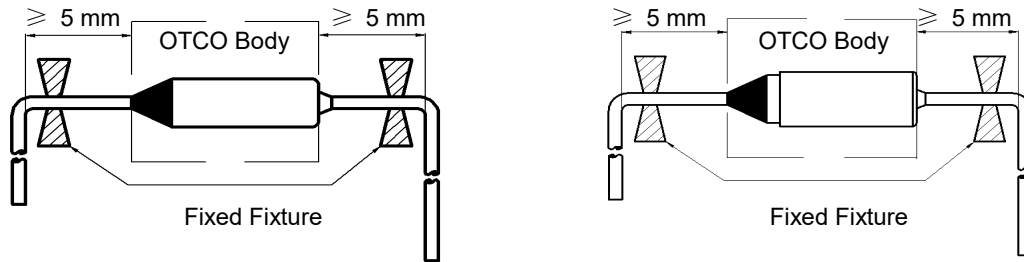

FIGURE 1

1. If lead wires has to be bent, it is important not to apply excessive pressure to the root of the lead wires. The tensile forces applied to the lead wires shall not exceed 22.7 N, and the thrust force applied to the lead wires shall not exceed 5.65 N.
2. The lead wires should be bent at a distance 5 mm or above from the body of OTCO (see Fig.1).
3. To avoid damaging the OTCO, when bending lead wires, please use pincher or similar tools to fix the OTCO.

Installation

Selection of Installation Location

1. Do not locate the OTCO in a place where severe vibration always occurs.
2. To reduce the deviations between the temperature design and the actual situation, it is recommended that the OTCO be installed in close to the thermostat or temperature sensor.

Make Sure the Temp. of Installation Location

1. The body of OTCO will generate heat as current flows through it, resulting the body temp. higher than ambient temp. The influence of temp. rise shall be considered in the design to determine the appropriate OTCO model.
2. It Considering possible temperature shock situations, it is recommended that the temperature of the body and the ambient temperature of the installation location during the operation of the temperature fuse should not exceed $(T_h-10)^\circ\text{C}$.
3. The end product should be tested to ensure that potential abnormal conditions do not cause ambient temp. to exceed the T_m of the OTCO.

Mounting OTCO

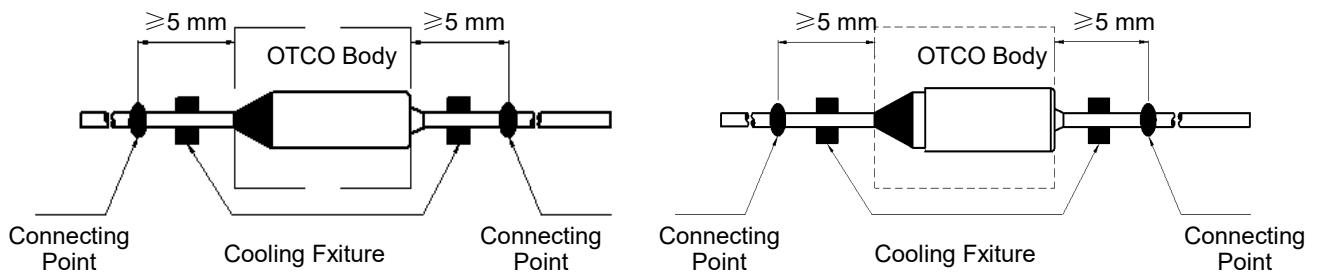

FIGURE 2

1. OTCO can be installed by soldering, welding, riveting or crimping. During and after installation, please do not pull, push or twist OTCO body or lead wires.
2. The connection point of the lead shall be no less than 5 mm away from the OTCO body (see Fig.2).
3. Try to ensure that the body of the OTCO is evenly heated. If the temp. difference is inevitable, make sure that the sealing resin side is connected close to the heat source.

Soldering

1. Soldering should be carried out according to below table. If secondary soldering is required, wait until the OTCO cools to room temp.
2. Soldering is not recommended for Thermal-Link with $T_r \leq 110^\circ\text{C}$, while non heating processes such as crimping and riveting are recommended.
3. In the process of soldering, cooling fixture should be used between soldering point and OTCO body (see Fig.2).
4. It is recommended to take X-ray after soldering, to confirm that the thermal pellet has no shrinkage after soldering.

TABLE 1: Max. Allowable Soldering Time for Different Length of Soldering Point from OTCO Body

Rated Functioning Temp. (T_r)	Length	Time	Length	Time	Length	Time	Max. Soldering Temp.
($^\circ\text{C}$)	(mm)	(s)	(mm)	(s)	(mm)	(s)	($^\circ\text{C}$)
≤ 110	5	N / A	15	N / A	25	N / A	400
111 ~ 150	5	N / A	15	1	25	2	
151 ~ 190	5	1	15	2	25	3	
≥ 191	5	1	15	3	25	5	

Welding

1. Avoid welding current flowing into the inside of the OTCO. The welding current will cause the internal parts to be welded together, resulting in the failure function of OTCO.
2. During the welding process, the lead wires of the OTCO must be supported to avoid the damage of the OTCO.
3. In the process of welding, cooling fixture should be used between welding point and OTCO body (See Fig.2).
4. It is recommended to take X-ray after welding, to confirm that the thermal pellet has no shrinkage after welding.

Riveting or Crimping

1. Select materials with low resistance (such as copper) for riveting and crimping.
2. Contact resistance shall be as small as possible. Large contact resistance will cause high temp. to make OTCO open in advance.
3. It is better to crimp OTCO leads to stranded lead wires rather than solid wires as the stranded wire may be crimped tighter and maintain better electrical contact during temp. cycling.
4. During the riveting and crimping process, ensure that the lead wires shall not be reversed, sealing resin shall not be destroyed.
5. When the working temp. exceeds 150°C , soldering reinforcement is recommended after riveting and crimping.

The isolated lead is forbidden to contact OTCO body directly to avoid short circuit (See Fig.3).

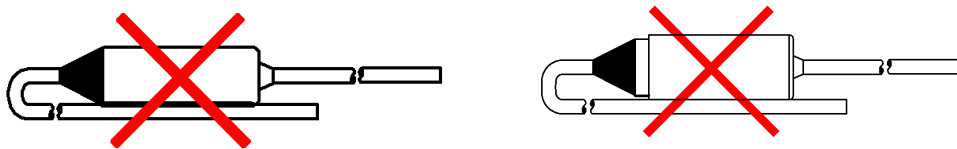

FIGURE 3

Thermal-Link (OTCO)-Organic Type

RK Series I_r : 20A

Thermal-Link (OTCO) - Organic Type Features & Model List Overview

Rated Functioning Temp. T_f (°C)	Model										I_r (A) Rated Current (VAC)	U_r Rated Voltage (VDC)	Product Structure			
	RB310	RS310	RT310	RK310	RU310	RP310	RL310	RM310	RB275	RS275				RT275	RK275	RU275
263	RB263	RS263	RT263	RK263	RU263	RP263	RL263	RM263	RB257	RS257	RT257	RK257	RU257	RP257	RL257	RM257
240	RB240	RS240	RT240	RK240	RU240	RP240	RL240	RM240	RB229	RS229	RT229	RK229	RU229	RP229	RL229	RM229
216	RB216	RS216	RT216	RK216	RU216	RP216	RL216	RM216	RB205	RS205	RT205	RK205	RU205	RP205	RL205	RM205
205	RB192	RS192	RT192	RK192	RU192	RP192	RL192	RM192	RB184	RS184	RT184	RK184	RU184	RP184	RL184	RM184
184	RB172	RS172	RT172	RK172	RU172	RP172	RL172	RM172	RB167	RS167	RT167	RK167	RU167	RP167	RL167	RM167
172	RB157	RS157	RT157	RK157	RU157	RP157	RL157	RM157	RB152	RS152	RT152	RK152	RU152	RP152	RL152	RM152
167	RB144	RS144	RT144	RK144	RU144	RP144	RL144	RM144	RB134	RS134	RT134	RK134	RU134	RP134	RL134	RM134
157	RB128	RS128	RT128	RK128	RU128	RP128	RL128	RM128	RB121	RS121	RT121	RK121	RU121	RP121	RL121	RM121
152	RB117	RS117	RT117	RK117	RU117	RP117	RL117	RM117	RB110	RS110	RT110	RK110	RU110	RP110	RL110	RM110
144	RB104	RS104	RT104	RK104	RU104	RP104	RL104	RM104	RB99	RS99	RT99	RK99	RU99	RP99	RL99	RM99
134	RB98	RS98	RT98	RK98	RU98	RP98	RL98	RM98	RB94	RS94	RT94	RK94	RU94	RP94	RL94	RM94
128	RB84	RS84	RT84	RK84	RU84	RP84	RL84	RM84	RB77	RS77	RT77	RK77	RU77	RP77	RL77	RM77
121	RB72	RS72	RT72	RK72	RU72	RP72	RL72	RM72	10	10 / 15	16	20	25	30	16	25
117																
110																
104																
99																
98																
94																
84																
77																
72																

