

## Thermal Link P-F Series

## 2A Series





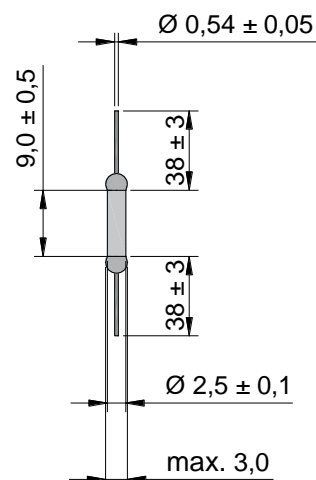

### Key Features

- Ceramic case
- Non-resettable
- High accuracy of function temperature
- RoHS & REACH compliant

### Dimensions



### Specification

Model	$T_f$	Fusing Temp.	$T_h$	$T_m$	$I_r$	$U_r$							
	(°C)	(°C)	(°C)	(°C)	(A)	(V)	UL recognized	cUL recognized	VDE	PSE	CCC	KTL	RoHS REACH
P1-F	102	98±2	80	200	2	AC 250	●	●	●	●	●	●	●
P2-F	115	112±3	99	200	2	AC 250	●	●	●	●	●	●	●
P3-F	125	120±3	105	200	2	AC 250	●	●	●	●	●	●	●
P4-F	130	126±2	107	200	2	AC 250	●	●	●	●	●	●	●
P5-F	135	131±3	115	200	2	AC 250	●	●	●	●	●	●	●
P9-F	138	135±2	118	200	2	AC 250	●	●	●	●	●	●	●
P12-F	145	140±2	126	200	2	AC 250	●	●	●	●	●	●	●
P7-F	150	145±3	128	200	2	AC 250	●	●	●	●	●	●	●